

# Garage Door Opener

Control System Instructions And User Guide

S/N	
-----	--

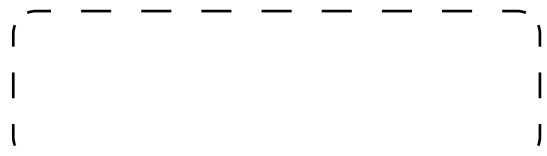



# Table Of Contents

1. Critical Safety Guidelines 01

2. Button/Coin Cell Battery Safety 02

3. Product Overview & Features 03

4. Technical Specifications 04

5. Port Wiring Configurations 06

6. Basic button instructions 07

7. Quick setting instructions 08

8. Parameter details 10

9. Running display codes 17

10. Common fault & solutions 18

# Table Of Contents

13. Running display codes

23

14. Common fault & solutions

24

# 1. CRITICAL SAFETY GUIDELINES

Failure to comply with these instructions may result in severe injury, death, or property damage.

1. Read and adhere to all safety and installation guidelines.

2. Installation Compliance:

- The opener complies with regional safety standards. Installers must verify alignment with local regulations.
- Only qualified personnel familiar with occupational health and safety standards for automated doors may perform installations.

3. Safety Responsibility:

- Installers/service providers failing to adhere to standards assume full liability for damages or injuries.

4. Photoelectric Sensor Recommendation:

- While the opener includes a pressure-sensitive safety system, installing a photoelectric sensor (Photo Beam) is strongly advised to enhance obstruction detection.

5. Operational Precautions:

- Ensure the door is fully stationary before entering/exiting the garage.
- Keep hands and loose clothing clear of moving components.

6. Safety Obstruction System Limitation:

- Designed for stationary objects only. Contact with moving objects may cause failure.

7. User Restrictions:

- Not intended for unsupervised use by children or individuals with reduced physical/mental capabilities.

8. Disposal:

- Dispose of electrical waste via certified recycling facilities.

9. Power Cord Safety:

- A damaged supply cord must be replaced by the manufacturer or certified personnel.

10. Monthly Safety Checks:

- Verify door reversal upon contacting a 50mm obstruction. Adjust if necessary.
- Inspect cables, springs, and mountings for wear/tear monthly.

11. Manual Release Warning:

- Exercise caution during manual release to prevent rapid door descent caused by spring failure.

12. Maintenance Protocol:

- Disconnect power before cleaning or servicing.

## 2. BUTTON/COIN CELL BATTERY SAFETY

### 1. WARNING:

- Contains a button/coin cell battery (lithium CR2032 or equivalent).
- Keep batteries out of reach of children. Ingestion may cause fatal injuries within 2 hours.
- Seek immediate medical attention if swallowed.

### 2. Transmitter Battery Replacement:

- Step 1: Remove screws on the transmitter's underside.
- Step 2: Replace battery with an identical specification (e.g., CR2032).
- Step 3: Verify red indicator illumination after reassembly.

### 3. PRODUCT OVERVIEW & FEATURES

Feature	Description
1. Adjustable Obstruction Force	Levels 1 (min) to 5 (max)
2. Energy saving - L.E.D courtesy light	3 minutes L.E.D light delay
3. Auto-Reverse Safety	Software-controlled reversal upon
4. Soft Start/Stop	Reduces mechanical stress and noise
5. Auto-Close	Activates after user entry/exit for security.
6. Self-learning open and close obstruction force	During setup, opener power for door travel is learnt, re - profiled, and force measurement is auto - adjusted
7. Available terminal	Terminals for wired photo beams, receivers, push button, lights, door protection devices
8. Transmitter technology	Rolling Code tech ( $7.38 \times 10^{19}$ combos), 433.92Mhz or 868.35Mhz frequency, 4-channel design for controlling 4 different doors with 1 transmitter

# 4. TECHNICAL SPECIFICATIONS

Model	FS 600	FS 1000	FS 1200
Input voltage	220 - 240V / 50-60 Hz		
Max. pull force	600 N	1000 N	1200 N
Max. door area	10 m <sup>2</sup>	15 m <sup>2</sup>	18 m <sup>2</sup>
Max. door weight (Balanced)	100 kg	150 kg	180kg
Max. door height	2400 - 3500mm	2400 - 3500mm	2400 - 3500mm
Drive mechanism	Chain / Belt	Chain / Belt	Chain / Belt
Opening / Closing speed	160mm / Second - C Rail		
L.E.D supply voltage (DC)	24V		
Limit setting	Electronic	Electronic	Electronic
Transformer	Overload protection technology		
Radio frequency	433.92 / 868.35 MHz		
Coding format	Rolling code (7.38 x 10 <sup>19</sup> Combinations)		
Status display transmitter	2 X	2 X	2 X
Code storage capacity	50 different codes (Subject to the actual)		
Caution light terminal	Included	Included	Included
Working temperature	-20°C - +60°C	-20°C - +60°C	-20°C - +60°C
Safety protection	Soft start & Soft stop, Photo cell option, Caution light option		
Protection level	IP20	IP20	IP20

FS 600

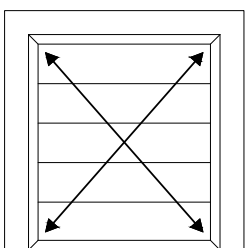

Rated door area: ≤ 10 m<sup>2</sup>

FS 1000

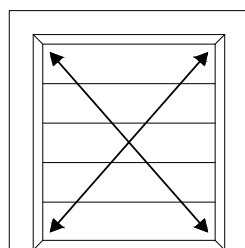

Rated door area: ≤ 15 m<sup>2</sup>

FS 1200

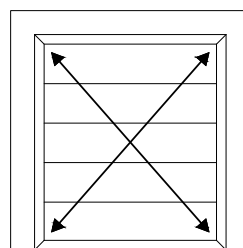

Rated door area: ≤ 18 m<sup>2</sup>

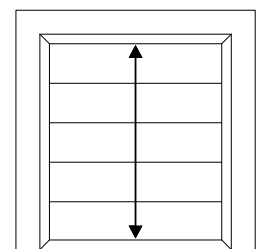

Standard door height: 2400mm  
Maximum door height: 3500mm



Model	FS 600-Speed	FS 1000-Speed
Input voltage	220 - 240V / 50-60 Hz	
Max. pull force	600 N	1000 N
Max. door area	8 m <sup>2</sup>	12 m <sup>2</sup>
Max. door weight (Balanced)	80 kg	120 kg
Max. door height	2400 - 3500mm	2400 - 3500mm
Drive mechanism	Chain / Belt	Chain / Belt
Opening / Closing speed	200mm / Second	200mm / Second
L.E.D supply voltage (DC)	24V	
Limit setting	Electronic	Electronic
Transformer	Overload protection technology	
Radio frequency	433.92 / 868.35 MHz	
Coding format	Rolling code (7.38 x 10 <sup>19</sup> Combinations)	
Status display transmitter	2 X	2 X
Code storage capacity	50 different codes (Subject to the actual)	
Caution light terminal	Included	Included
Working temperature	-20°C - +60°C	-20°C - +60°C
Safety protection	Soft start & Soft stop, Photo cell option, Caution light option	
Protection level	IP20	IP20

FS 600-Speed

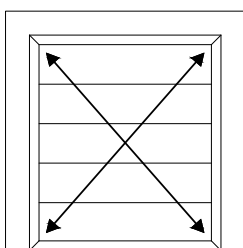

Rated door area: ≤ 8 m<sup>2</sup>

FS 1000-Speed

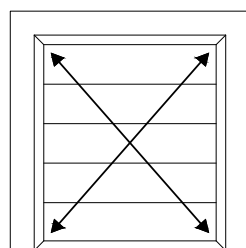

Rated door area: ≤ 12 m<sup>2</sup>

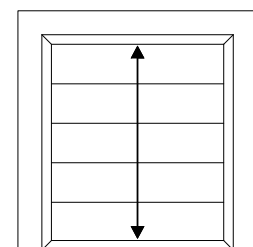

Standard door height: 2400mm  
Maximum door height: 3500mm

# 5. PORT WIRING CONFIGURATIONS



The garage door opener has above types of wiring ports. Please check your motor to find the corresponding port and wire it according to the diagram.

**Remark:** Please turn off low power mode before connecting external devices to the 24V / GND port.

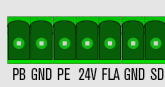

Long press the 0.4W button for 3 seconds to turn off the low standby mode.

The green indication light will turn off.

## Wired E-Lock (Optional)

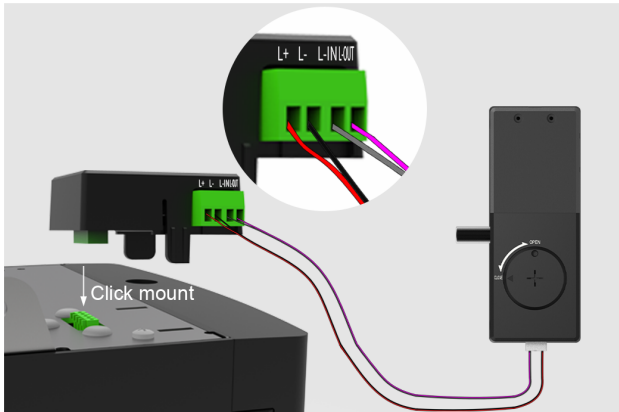

**Remark:** Activate the Wired E-LOCK function on the opener setting menu **P**

Connect the four wires of the wired E-Lock to the corresponding ports of the E-Lock external device:

- Red: L+
- Black: L-
- Gray: L-IN
- Pink: L-OUT

Click mount the relay module to the connection port of the GDO.

## Camera (Optional)

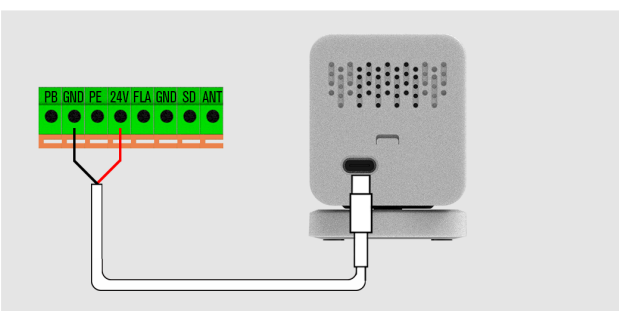

**Remark:** Before connecting the camera, please turn off the low standby mode. Otherwise the camera may not working properly.



Long press the 0.4W button for 3 seconds to turn off the low standby mode.



The green indication light will turn off.

Power connection from camera to opener.

## Universal receiver (Optional)

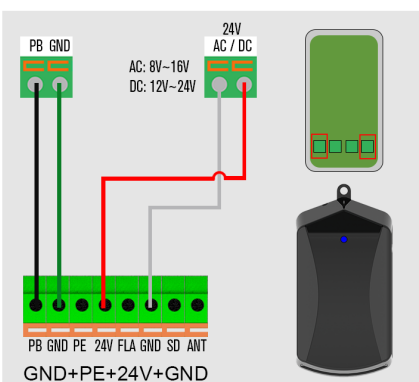

**Remark:** Before connecting the external receiver, please turn off the low standby mode. Otherwise the receiver may not working properly.

Long press the 0.4W button for 3 seconds to turn off the low standby mode.

The green indication light will turn off.

**Notice:**

Special attention to the wiring. Wire in red color should be always go to 24V port on garage door opener. In case of wrong wiring, there may cause damage to the receiver, or even other connected devices.

## Wired Photo Beam(Optional)

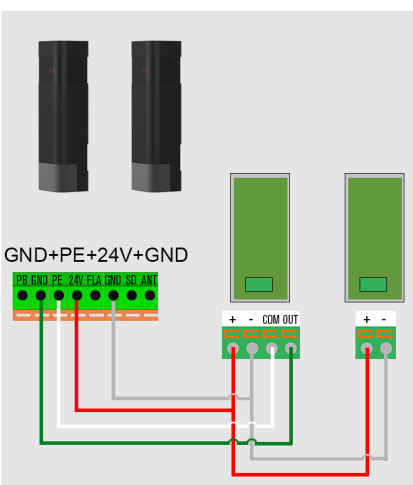

**Notice:**

Please ensure installation distance between 2 sensors is over 1 meter, otherwise garage door opener can not work properly

**Remark:**

1. When garage door opener is also connected with a Flash Light, the power of light should be lower than 10W, otherwise photo beam can't work properly due to low power supply.
2. PB (External Push Button) port should be with "NO" contact.



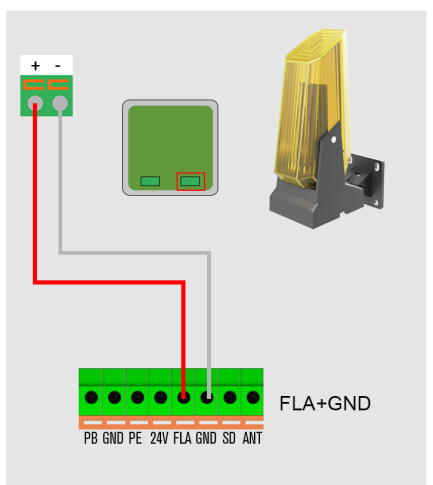

## Flash lamp (Optional)













Terminals provide 24-35v flash light voltage.



Connect the flash light with DC 24v-28v, current ≤ 100mA. When use AC 220V power flash lights, please match an adapter, and connect the wires as required.

## 6. BASIC BUTTON INSTRUCTIONS

Item	Button	Function Description
1.		<b>Short press:</b> Confirm setting. <b>Long press:</b> Enter the function menu setting.
2.		<b>Short press:</b> Remote coding. <b>Long press:</b> Clear the coded remote.
3.		<b>Short press:</b> Open the door. <b>Long press:</b> Auto closing on/off & Auto closing countdown time setting.
4.		<b>Short press:</b> Close the door. <b>Long press:</b> Wired photo beam function ON/OFF Setting
5.		<b>Long press:</b> Turn on/off the low standby mode.

# 7. QUICK SETTING INSTRUCTIONS

Quick Setup Function	Operation	Function Description
Auto closing on/off & Auto closing countdown Time setting	<p>Long press for 4 seconds</p> 	<ol style="list-style-type: none"> <li>1. Press and hold the UP button until a horizontal bar appears on the display. Now press the UP button once to set the auto close time (Unit: second).</li> <li>2. Press the UP button to increase the time, or the DOWN button to decrease the time.</li> <li>3. Press the SET button to confirm the setting.</li> <li>4. Factory default is set to  (disabled) as standard.</li> </ol>
Wired photo beam function ON/OFF	<p>Long press for 4 seconds</p> 	<ol style="list-style-type: none"> <li>1. Press and hold the DOWN button until  appears on the display. To enable the wired photo beam option, press the UP button again, the display will indicate  (enabled), or press the DOWN button to disable (display ) the option.</li> <li>2. Press the SET button to confirm the setting.</li> </ol>
Remote coding	<p>Short press</p> 	<ol style="list-style-type: none"> <li>1. In the Setting Status, short press CODE, it will exit the current operation and return to the standby interface.</li> <li>2. In the Standby Status, short press the CODE, A dot will be indicated in the corner, now entering the code leaning mode. Now first click the button on the hand transmitter you want to use, the dot may disappear, then press again the same button on the hand transmitter, the dot will flash, here, the code learning is finished.</li> </ol>
Remote clearing	<p>Long press</p> 	<p>Press and hold CODE button until a letter  is indicated on the display.</p> <p>All stored remotes will be deleted.</p> <p><b>Note:</b> Clearing the remote will not clear all paired wireless accessories.</p>
Over load mode	<p>Long press for 4 seconds</p>  <p>+</p> 	<p>Press and hold the UP button for 4 seconds. The digital display will increment and cyclically show levels 0-3. Release the button to select the current level.</p> <p>0: means the function is disabled (default)</p> <p>1: increase the overload force 25% based on your current force.</p> <p>2: increase the overload force 50% based on your current force.</p> <p>3: increase the overload force 75% based on your current force.</p>

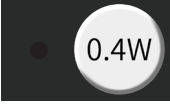
Quick Setup Function	Operation	Function Description
Low standby mode	Long press for 3 seconds 	<div data-bbox="592 371 762 474">  </div> Turn on the low standby mode.  <div data-bbox="592 510 762 613">  </div> Turn off the low standby mode.

# 8.PARAMETER DETAILS

## : Programming Open & Close Limits

- ① Pre-Setup Preparation: Manually open the door to half-height to avoid incorrect rotation during setup. Entering the travel limit menu will clear previous settings.
- ① Motor Direction Verification: Confirm motor output direction aligns with door movement

### 1. Enter travel limit setting

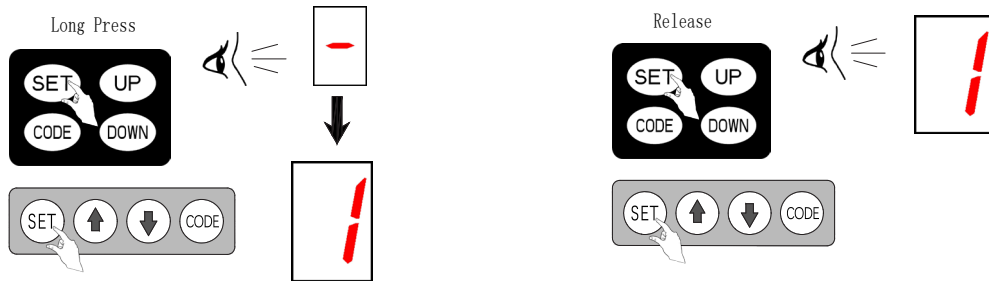

### 2. Check the direction of motor output and the door running operation

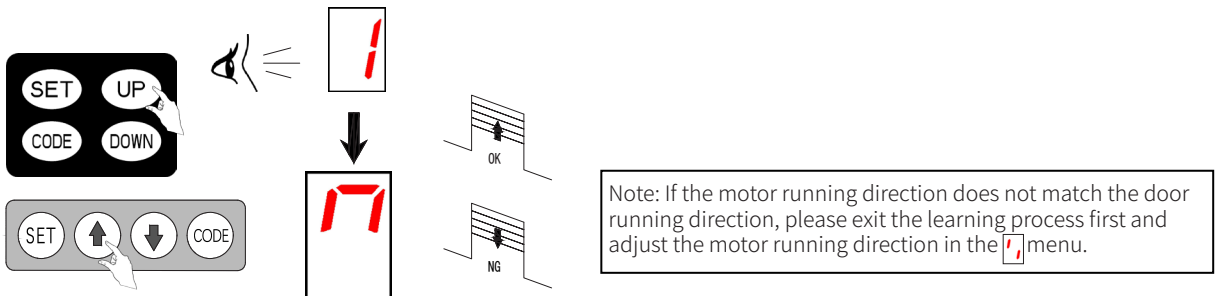

### 3. Start the travel limit set, open the door and move the door to the open limit position

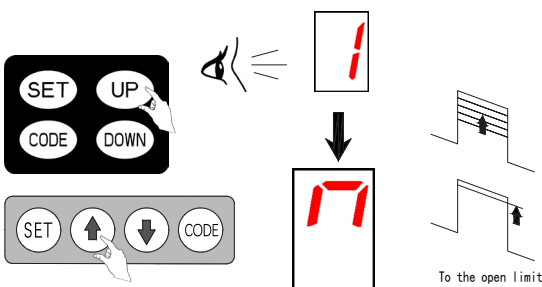

#### 4. Save open limit position

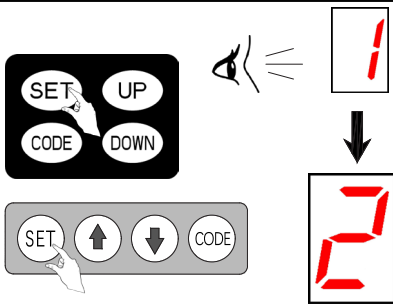

#### 5. Close the door and move the door to the close limit.

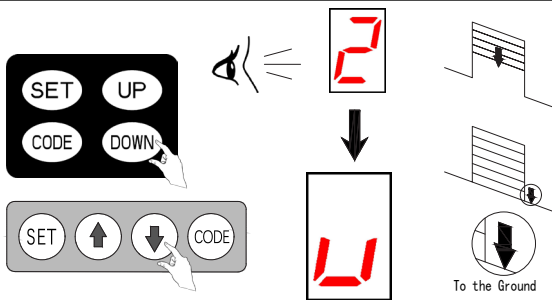

#### 6. After confirming the close limit position, the motor enters into self-learning. When the motor self-learning is complete, the travel limit set is complete.

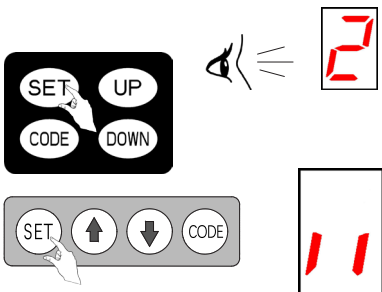



## Parameter: Obstruction Force Adjustment

① **Note:**

Automatically configured during initial setup. Manual adjustment is unnecessary normally.

① **Default:** Level 3 (Medium force).

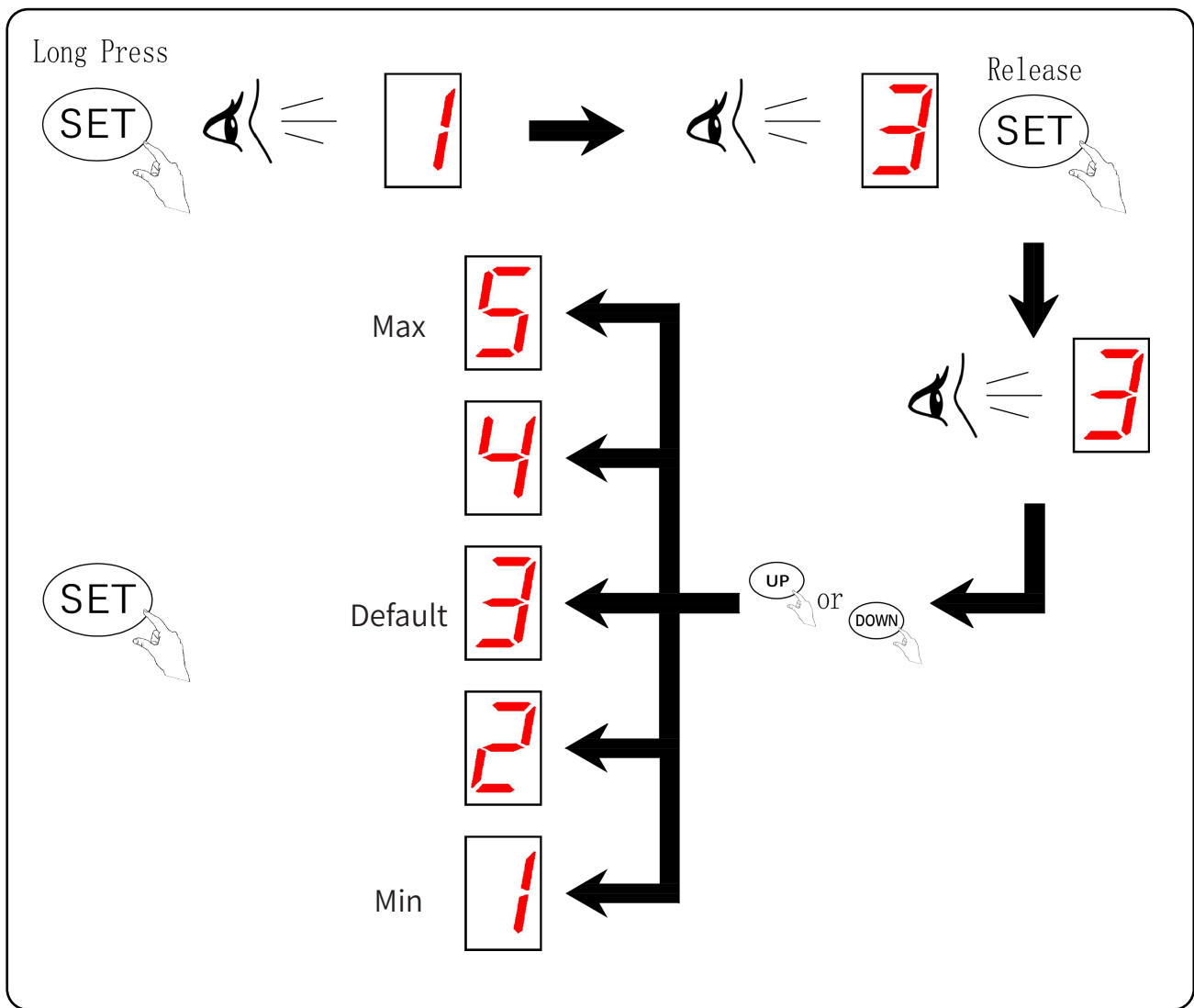



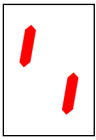

## : Programming Motor Forward / Reversal rotation.

① This function is applicable to swing doors. When enabled, the trolley moves forward during door opening and backward during closing.

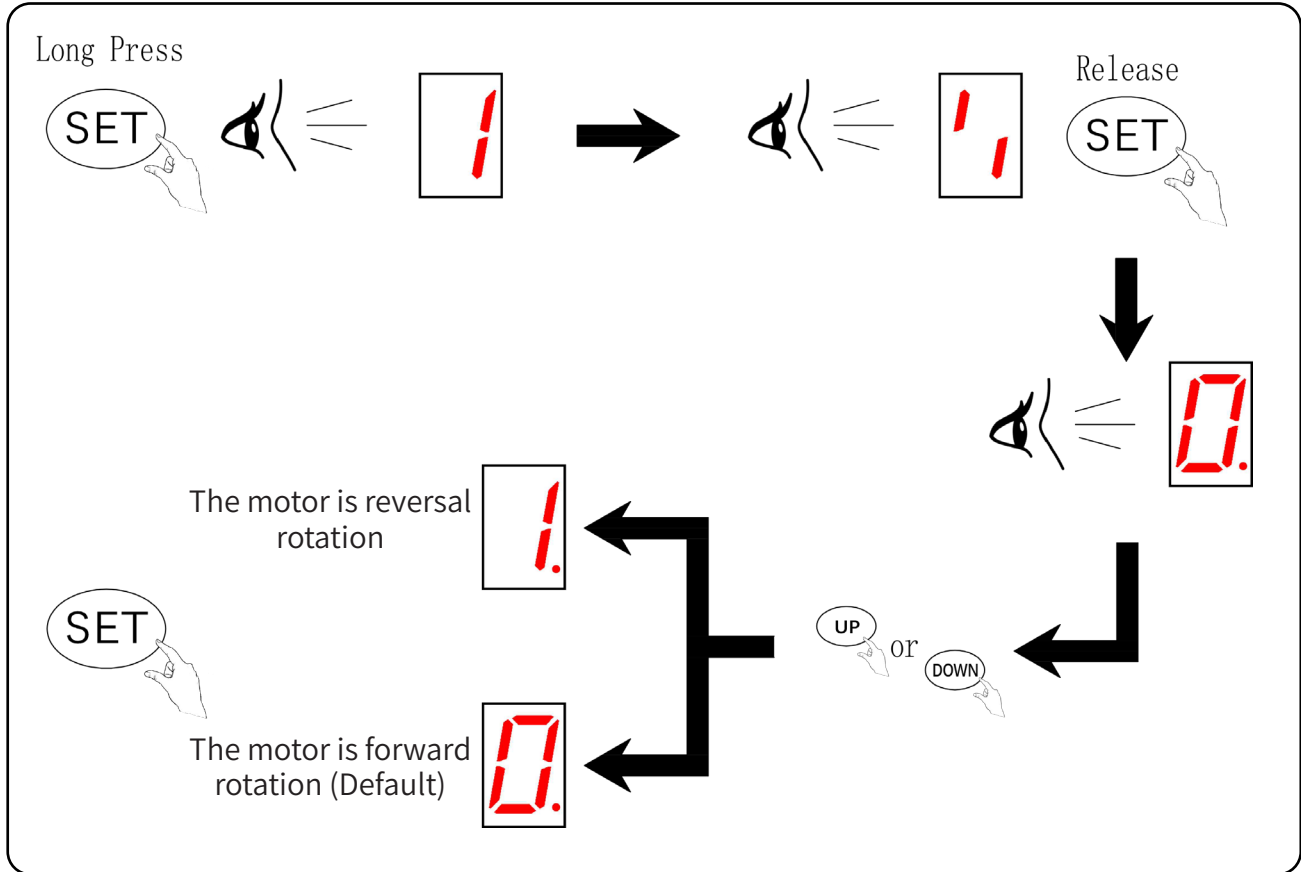

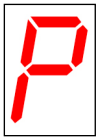

# : Wired E-Lock Function ON/OFF

① Connect the wired E-lock to the E-lock port of the motor.

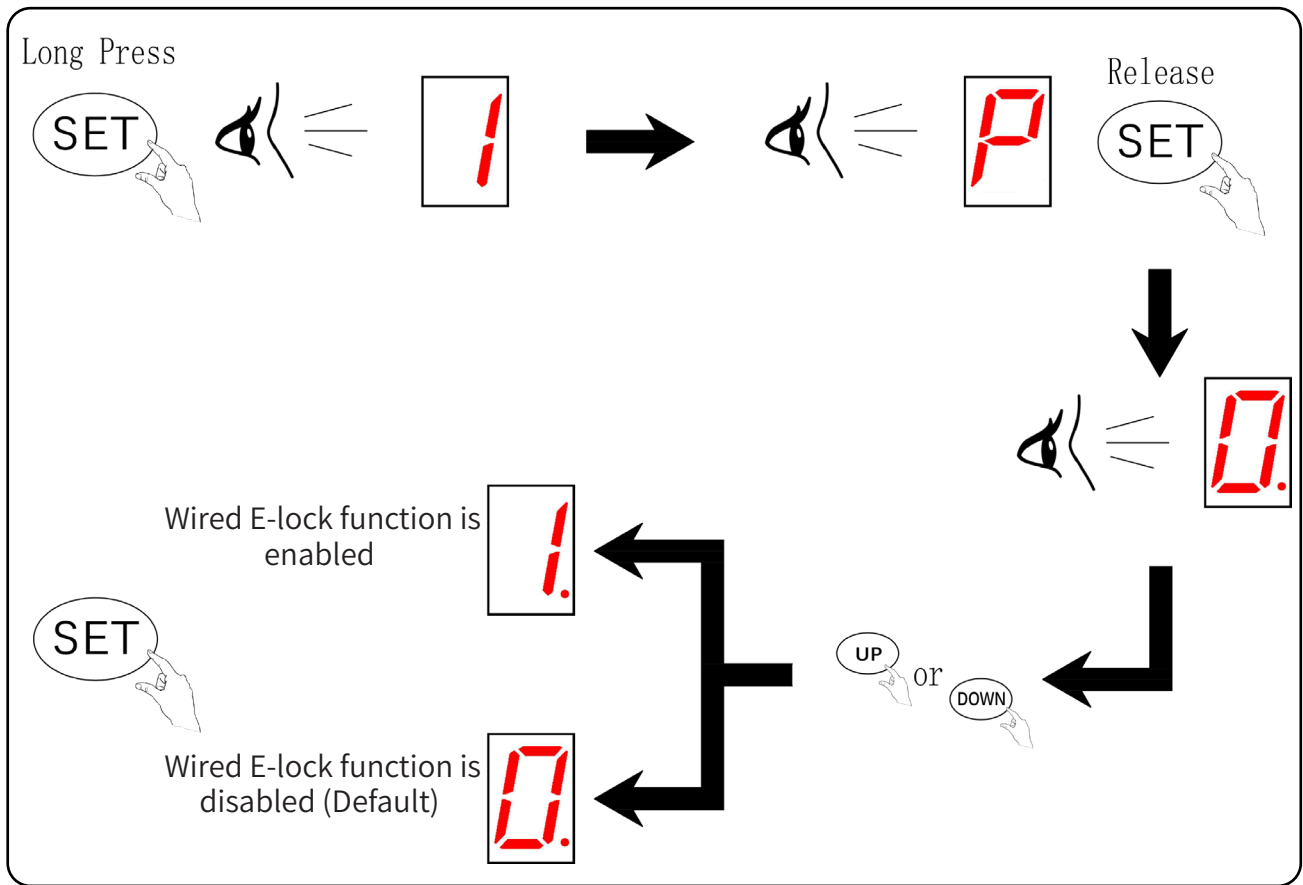

Wired E-lock wiring diagram:

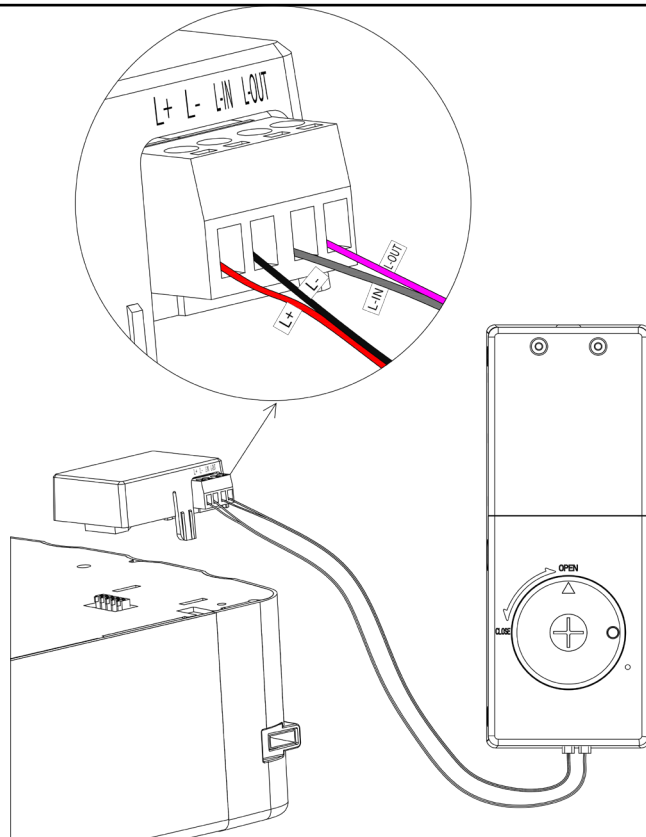

# Long Press **UP** :

## Auto closing on/off & Auto closing countdown time setting.

- ① Range: 1–135 seconds (9 intervals).
- ① Prerequisite: Photo beam function must be enabled.
- ① Behavior: Obstructions pause the timer, which resumes after clearance.

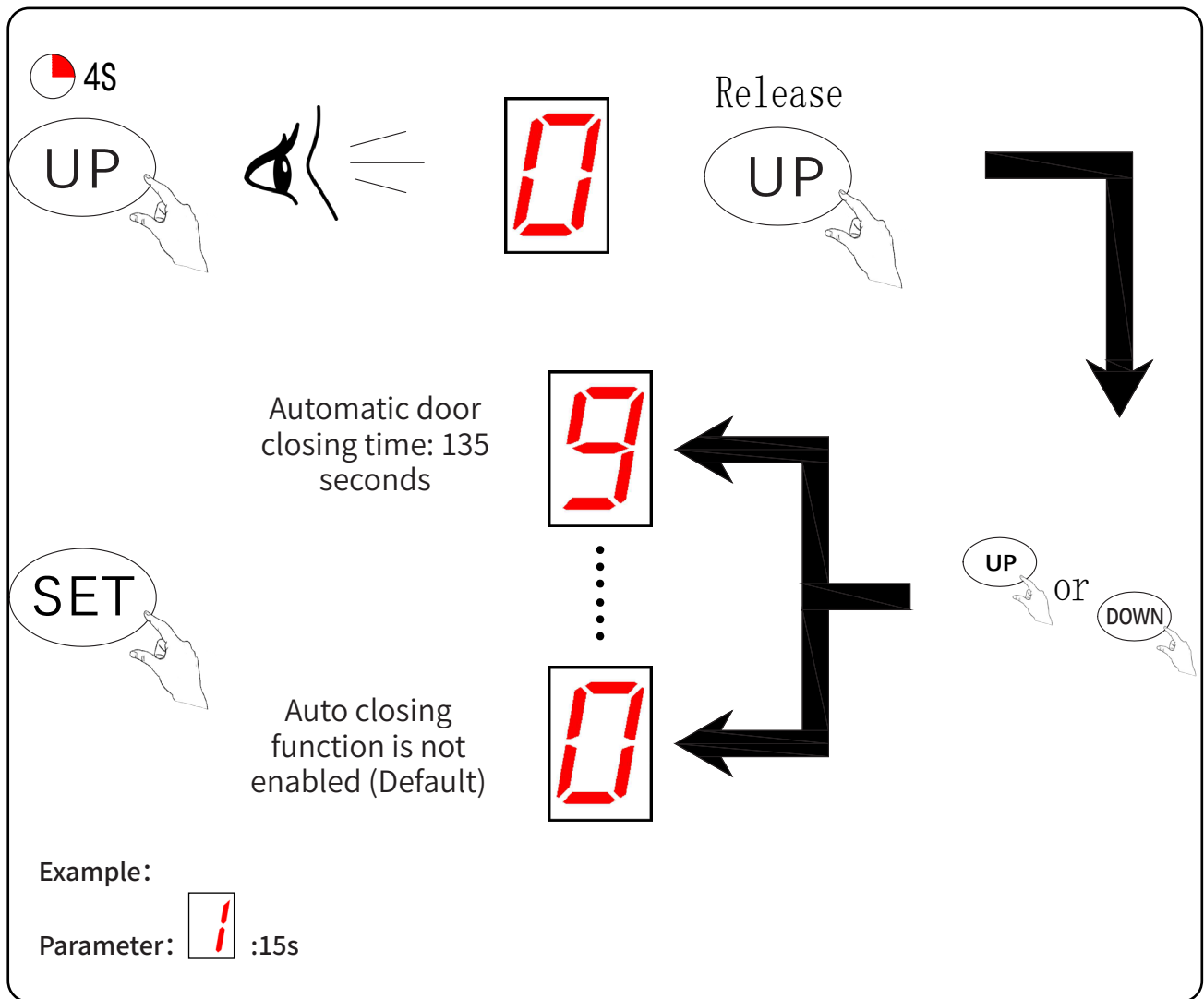



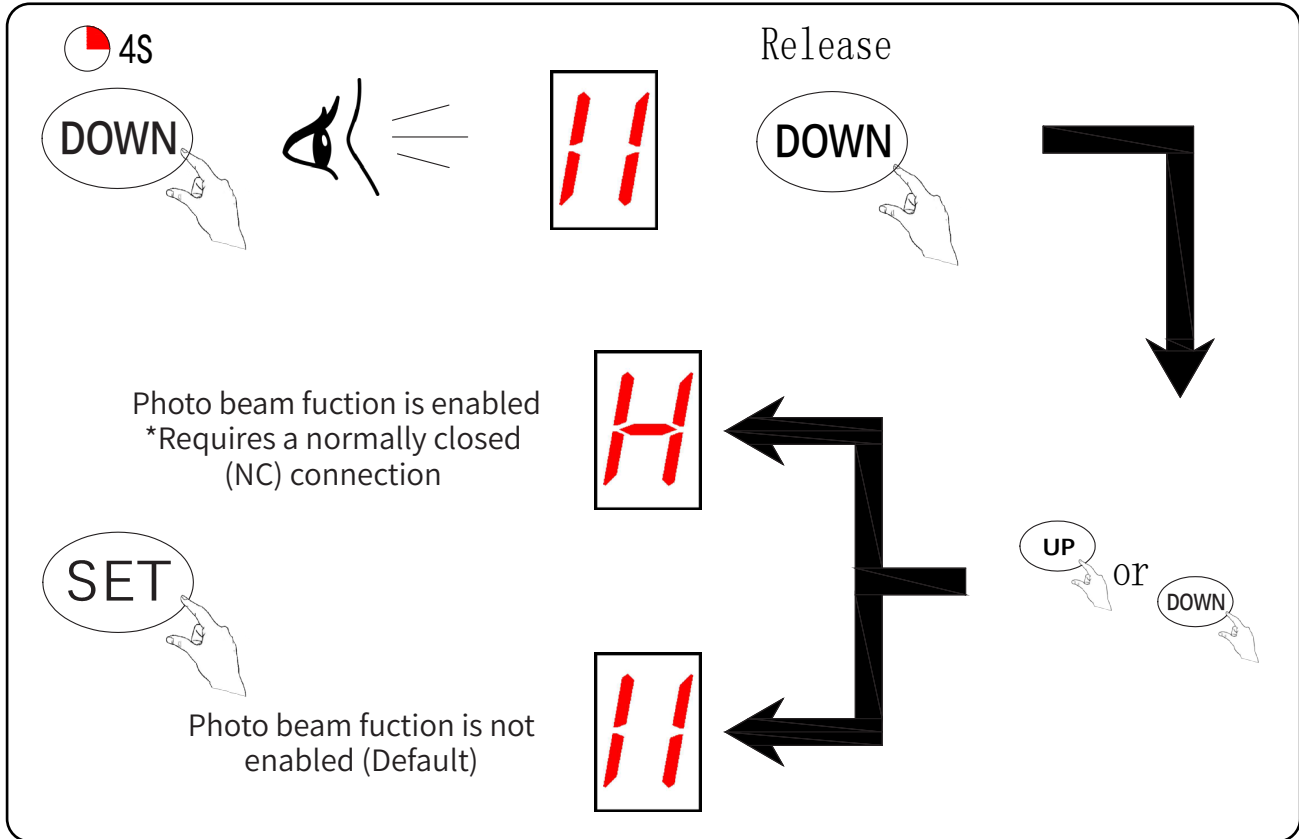

Long Press **DOWN** :

## Wired photo beam function ON/OFF Setting



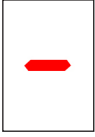
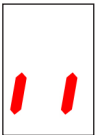
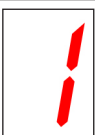

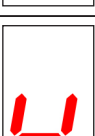
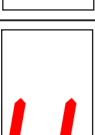
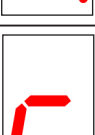

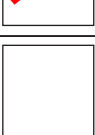

① Connection Description: PE-GND port



# 9. RUNNING DISPLAY CODES

Display information	
	No travel limit set
	Standby status display
	Open limit learning status display
	Close limit learning status display
	Door is opening
	Door is closing
	Pass door triggered
	Wired photo beam triggered
	Wired E-lock triggered
	Transmitter learning

# 10.COMMON FAULT & SOLUTIONS

Fault display code	Problem Description	Solution
	1. Door travel range exceeds maximum threshold (9m) or falls below minimum requirement (30cm). 2. The door loses balance and affects the proper operation of the motor.	1. Learn the proper travel limit range. 2. Check the door balance (Mechanical parts and springs) or replace a stronger power motor.
	Abnormal voltage input (A low input voltage), or unbalanced door weights.	1. Check the power supply for a right input voltage. 2. Check the door balance (Mechanical parts and springs) or replace a stronger power motor.
	Fail to learn the up and down limit setting Improperly learn the up and down limit setting	Learn "UP" and "DOWN" limit setting again follow the manual
	Hall sensor/wiring fault/ Component fault on PC board.	1. Inspect connections. 2. Replace the PC board.
	Reversed Motor Wiring to PC board.	1. Disconnect from main power supply. 2. Reverse the polarity of gear motor wiring connections at the terminal block. 3. Programme the travel limit.
	The wired photo beam function remains active despite no photo beam being installed.	1. Deactivate the wired photo beam function refer to the manual. 2. Verify proper wiring termination and ensure no physical obstructions are interfering with photoelectric detection.
	Exceeds limit of paired remote controls.	Delete all stored codes on the Opener (Refer the instruction manual).
	Pass door safety protection function is triggered	1. Check the pass door and ensure it has been closed completely. 2. Check the pass door sensor performance.
	1. Wired E-Lock is triggered or faults. 2. The wired E -Lock function (Parameter "P") has been enabled but no wired E-lock is installed.	1. Inspect the electrical connections of the wired E-lock for proper termination and continuity. 2. Verify the operational integrity of the wired E-lock, checking for Physical damage or component malfunction. Improper retraction of the locking bolt mechanism.

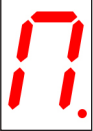
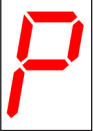
Fault display code	Problem Description	Solution
	<p>Activated the low standby mode when a USB-WIFI module</p>	<p>Low standby mode fails to activate when a USB-WIFI module is installed Remove the USB-WIFI module before restarting low standby mode</p>
	<p>Activated the low standby mode when the wired E-Lock function had been enabled on the motor.</p>	<p>Low standby mode fails to activate when the wired E-Lock function had been enabled on the motor Turn off the wired E-Lock function before restarting low standby mode</p>

<b>Fault Symptom</b>	<b>Potential Causes</b>	<b>Recommended Solutions</b>
No Response from Openers	1. Power supply interruption	1. Inspect E-Lock wiring integrity
	2. Loose wiring connections	2. Verify E-Lock functionality (ensure bolt retracts properly)
LCD Screen Inoperative	1. Power supply failure	1. Check main power input
	2. Faulty E-Lock mechanism	2. Replace damaged E-Lock components
Position Calibration Error	System limit setting misalignment	Reset travel limits via control panel
LED Indicator Continuously On	1. Control panel malfunction	Replace control board or power supply board
	2. Power board failure	
Caution Light Persists	Circuit board damage	Replace main circuit board
LED Failure	1. Disconnected LED wiring	1. Reconnect LED cables
	2. LED unit defect	2. Install new LED module
	3. Circuit board fault	3. Replace circuit board
Premature Door Reversal	1. Obstruction detected	1. Clear obstruction path
	2. Incorrect door installation	2. Reinstall door track
	3. Travel limit misaligned	3. Adjust force sensitivity and reset travel limits



<b>Fault Symptom</b>	<b>Potential Causes</b>	<b>Recommended Solutions</b>
Door Halts During Opening	1. Safety sensor activation	1. Clean sensor lenses
	2. Track misalignment	2. Realign door track
	3. Foreign object blockage	3. Remove obstructions
Remote Control Malfunction	1. Depleted battery	1. Replace battery
	2. Antenna disconnection	2. Secure/extend antenna
	3. Signal interference	3. Eliminate nearby RF sources
Remote Pairing Failure	Incompatible remote model	Use manufacturer-approved remote control
Motor Runs, Door Static	Motor-rail coupling failure	Inspect and reattach motor-drive rail linkage
Battery Failure	1. Discharged battery	1. Recharge battery
	2. Reverse polarity connection	2. Verify terminal orientation (+/-)
	3. Damaged wiring	3. Replace defective cables
Other Anomalies	External device incompatibility	1. Disconnect non-certified devices
		2. If unresolved, replace circuit board